



BE CREATIVE

Wide collection of highly customisable items, paired with low MOQ and short delivery dates.



new



BE CREATIVE



ColourMe AP718065

Non-woven, colouring shopping bag with 6 pcs crayon set. Price includes printing of 1 colour logo contour. MOQ: 100 pcs. 340x440 mm
Printing: FP (1C, 250x250 mm)

Malter
AP791927



VISION FILM printing



Xaloc
AP791584

Bunner
AP741350

Customise our compatible sunglasses with Vision Film Printing!



*With your own
sublimation
printed design!*



Subyard A AP718034

Custom made, polyester lanyard with metal carabiner. With sublimation printed graphics on both sides. MOQ: 100 pcs. Request price for higher quantity!
20x450 mm
Printing: FP (FC, 20x900 mm)

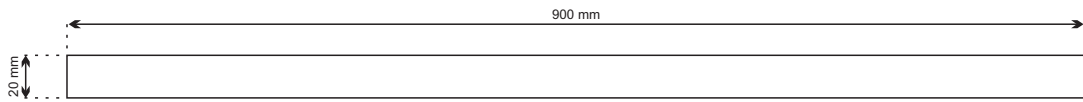

Subyard C AP718036

Custom made, polyester lanyard with detachable metal carabiner. With sublimation printed graphics on both sides. MOQ: 100 pcs. Request price for higher quantity!
20x450 mm
Printing: FP (FC, 20x900 mm)



Subyard B AP718035

Custom made, polyester lanyard with metal carabiner and mobile string. With sublimation printed graphics on both sides. MOQ: 100 pcs. Request price for higher quantity!
20x450 mm
Printing: FP (FC, 20x900 mm)



Subyard D AP718037

Custom made, polyester lanyard with detachable metal carabiner and mobile string. With sublimation printed graphics on both sides. MOQ: 100 pcs. Request price for higher quantity!
20x450 mm
Printing: FP (FC, 20x900 mm)

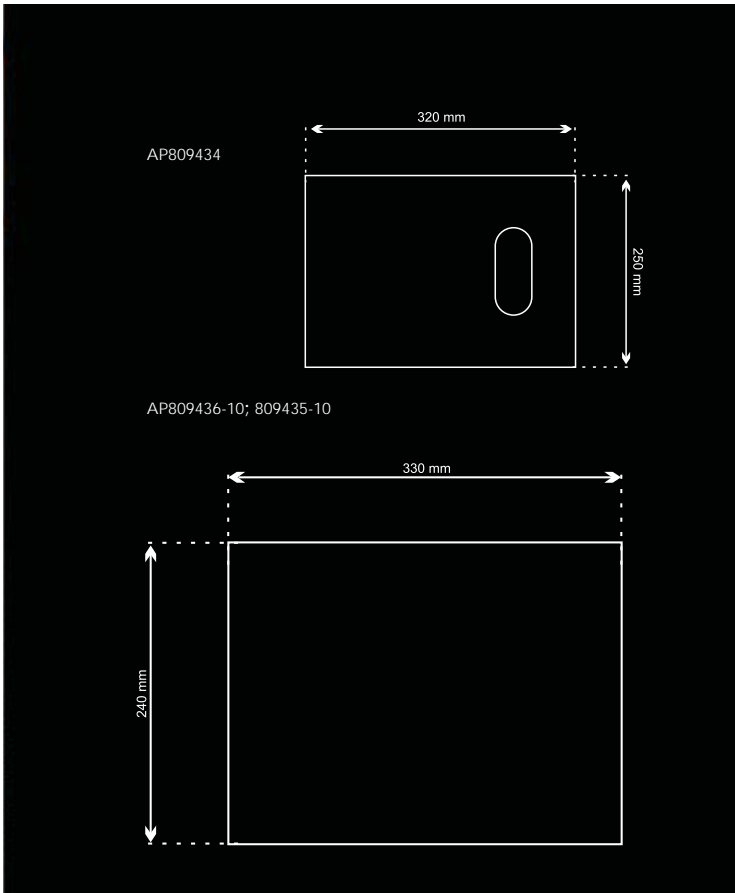

new



Subster AP809434

Non-woven shopping bag with custom graphics on both sides. 80 gr/m². Price includes sublimation printing. MOQ: 100 pcs. 250×320 mm
Printing: FP (FC, 250×320 mm)



Submine AP809436-10

Non-woven shoulder bag with adjustable strap and custom graphics on front side. 80 gr/m². Price includes sublimation printing. MOQ: 50 pcs. 330×260×100 mm
Printing: FP (FC, 330×240 mm)



Substore AP809435-10

Non-woven shopping bag with custom graphics on front side. 80 gr/m². Price includes sublimation printing. MOQ: 50 pcs. 330×330×127 mm
Printing: FP (FC, 330×240 mm)

*With your own
sublimation printed
design!*



AP718012-01

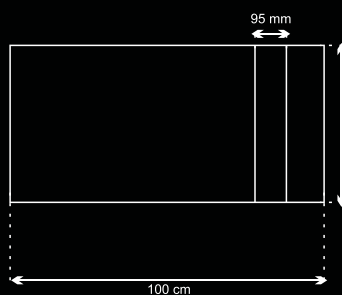

AP718011-01

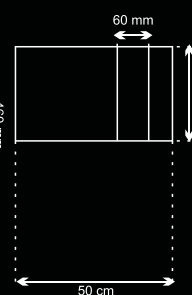

AP718013-01

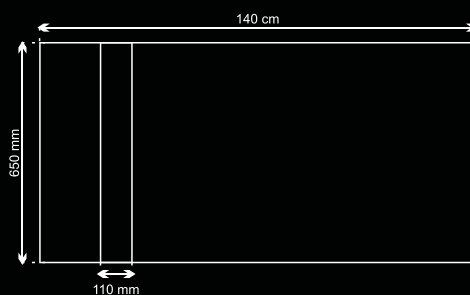

Subowel S AP718011-01

100% cotton, 380 g/m² terry towel with polyester border for sublimation printing. Price includes sublimation printing. MOQ: 50 pcs.
30×50 cm
Printing: FP (FC, 300×60 mm)



Subowel M AP718012-01

100% cotton, 380 g/m² terry towel with polyester border for sublimation printing. Price includes sublimation printing. MOQ: 50 pcs.
50×100 cm
Printing: FP (FC, 460×95 mm)



Subowel L AP718013-01

100% cotton, 380 g/m² terry towel with polyester border for sublimation printing. Price includes sublimation printing. MOQ: 50 pcs.
70×140 cm
Printing: FP (FC, 650×110 mm)



BE CREATIVE

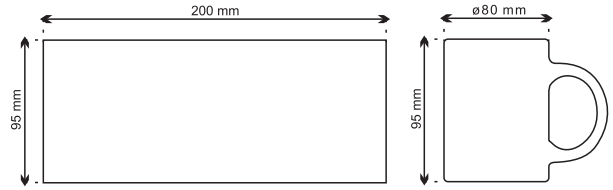

Magic AP812401

Dishwasher safe, white ceramic mug for sublimation printing, 300 ml. Price includes printing. MOQ: 100pcs. ø80×95 mm
Printing: FP (FC, 95×200 mm)

MultiColour AP812400

Dishwasher safe, white ceramic mug for sublimation printing, 300 ml. Price includes printing. MOQ: 100pcs. ø80×95 mm
Printing: FP (FC, 95×200 mm)

Alloy AP809476

Metallic ceramic mug for sublimation printing, 300 ml. Price includes printing. MOQ: 100pcs. ø80×95 mm
Printing: FP (FC, 95×200 mm)

Harnet AP791325

Ceramic sublimation mug coloured inside and matching colour handle, in gift box. 350 ml. ø82×100 mm
Printing: SU1 (FC, 95×200 mm)





*With your own
sublimation printed
design!*

new



Manchester AP718069

Custom made football jersey and shorts with sublimation printed graphics. Made of dry-fit polyester. MOQ: 10 sets. 122; 134; 146; S-XXXL
Printing: FP (FC, FULL)



BE CREATIVE

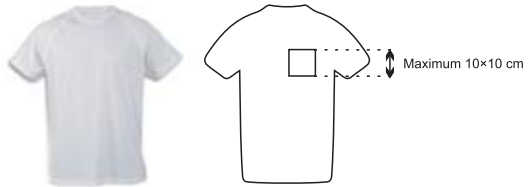

Suboplus T AP718073-01

Breathable adult T-shirt with sublimation printing, 100% polyester, 135 g/m². Price includes 10x10 cm sublimation printing on the front side. MOQ: 50 pcs. S-XXL
 Printing: FP (FC, 100x100 mm)



Suboplus K AP718074-01

Breathable kids T-shirt with sublimation printing, 100% polyester, 135 g/m². Price includes 10x10 cm sublimation printing on the front side. MOQ: 50 pcs. 4-5; 6-8; 10-12
 Printing: FP (FC, 100x100 mm)



Roubaix AP718072

Custom made cycling jersey with sublimation printed graphics. Made of dry-fit polyester. MOQ: 10 pcs. S-XXXL
 Printing: FP (FC, FULL)



Ottawa AP718071

Custom made hockey jersey with sublimation printed graphics. Made of polyester. MOQ: 10 pcs. 122; 134; 146; S-XXXL
 Printing: FP (FC, FULL)



Chicago AP718070

Custom made basketball jersey and shorts with sublimation printed graphics. Made of dry-fit polyester. MOQ: 10 sets. 122; 134; 146; S-XXXL
 Printing: FP (FC, FULL)

new

*With your own
sublimation printed
design!*

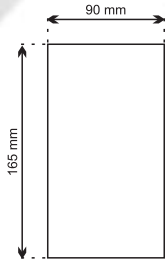

SuboCall AP718064

Custom made, polyester mobile phone case with sublimation printed graphics.
MOQ: 200 pcs.
90x165 mm
Printing: FP (FC, 90x165 mm)

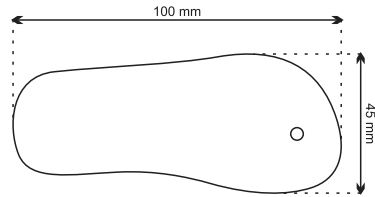

Flopper AP800361

Beach slipper shaped sublimation keyring with metal chain. The product's whole upper surface can be customised. Sole thickness: 10 mm. Price includes sublimation printing.
MOQ: 100 pcs.
45x100x10 mm
Printing: FP (FC, 100x45 mm)

Imagine AP800360

Sublimation beach slippers with natural rubber sole and strap. The product's whole upper surface can be customised. Sole thickness: 10 mm. Price includes sublimation printing.
MOQ: 25 pcs.
S (37-38), M (41-42), L (43-44)
Printing: FP (FC, 260x310 mm)

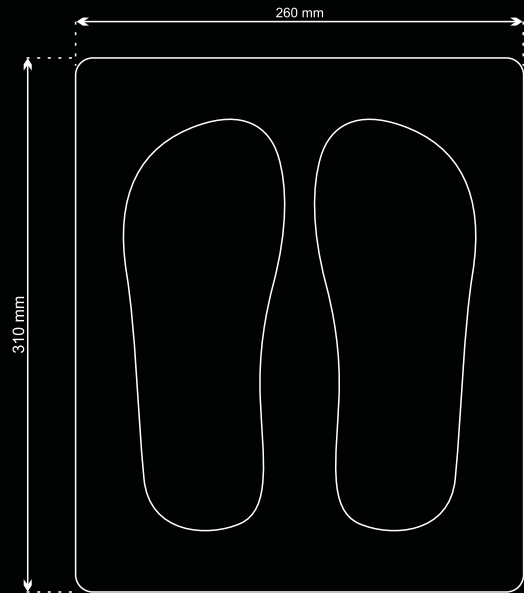

BE CREATIVE



Dioptry AP800348

Microfiber (180 gr/m²) cleaning cloth for glasses. Produced with unique design on request, price includes sublimation printing. MOQ: 100 pcs. 130×180 mm
Printing: FP (FC, 180×130 mm)



Sight AP809339

Microfiber cleaning cloth for glasses, in soft plastic pouch with keyring. Size of the cloth: 130×180 mm. ø60×15 mm
Printing: P1 (1C, 60×10 mm), SU1 (FC, 130×180 mm)

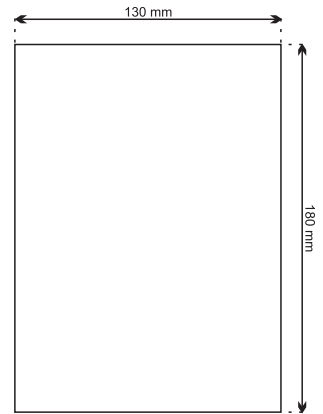

Suboknot AP718039

White polyester necktie for sublimation. Price includes sublimation printing. MOQ: 50 pcs. 1460×90 mm
Printing: FP (FC, 90×1000 mm)

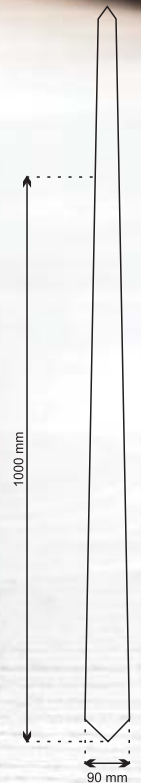

Customise them with sublimation printing!



Suboside AP809485-01

Foldable sublimation car sunshades for side windows, 2 pcs. Delivered with suction cups.
440x360 mm
Printing: SU3 (FC, 440x360 mm)

Subowind AP809486-01

Foldable sublimation car sunshade for windshield. Delivered with suction cups.
1000x500 mm
Printing: SU3 (FC, 1000x500 mm)



new

Champion AP718063

Custom made car headrest cover set (2 pcs) with sublimation printed graphics. Made of polyester.
MOQ: 100 sets.
300x280 mm
Printing: FP (FC, 300x280 mm)

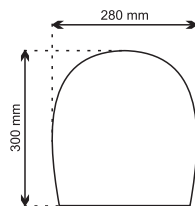

AP809486-01

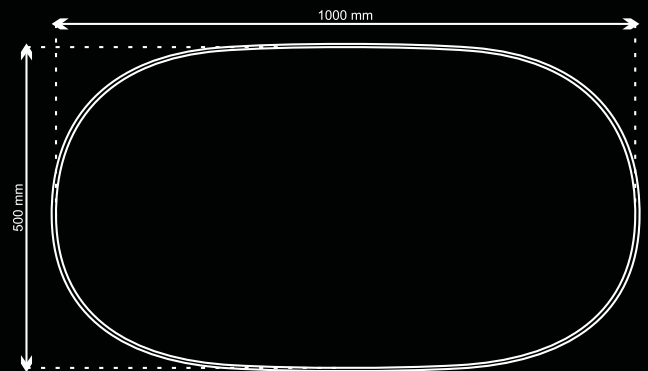

AP809485-01

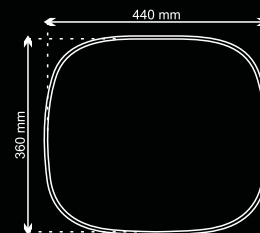

BE CREATIVE



Subomat AP812410

Mouse pad for sublimation printing. Price includes sublimation printing. MOQ: 50 pcs. Material: rubber and polyester. 230x190x1,5 mm
Printing: FP (FC, 230x190 mm)

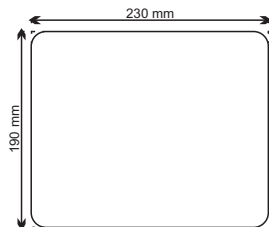

Suzzle AP812411

80 pcs puzzle for sublimation printing. Price includes sublimation printing. MOQ: 50 pcs. 190x240 mm
Printing: FP (FC, 190x240 mm)

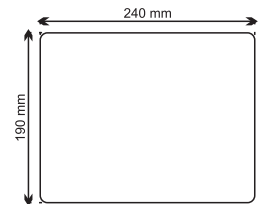



new

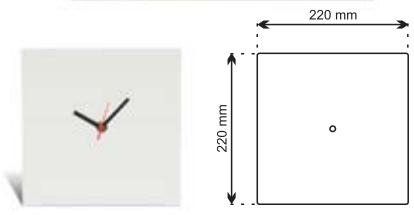

BeTime B AP718053

Custom made, square shaped HDF wood wall clock with custom graphic. Operates with 1 AA battery, without battery. MOQ: 50 pcs. 220x200 mm
Printing: FP (FC, 220x200 mm)



new

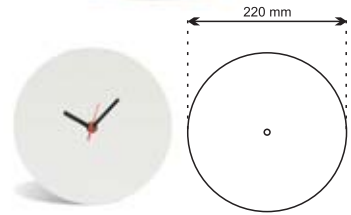

BeTime D AP718055

Custom made, round shaped HDF wood wall clock with custom graphic. Operates with 1 AA battery, without battery. MOQ: 50 pcs. ø220 mm
Printing: FP (FC, ø220 mm)



new

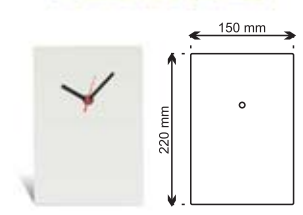

BeTime C AP718054

Custom made, rectangle shaped HDF wood wall clock with custom graphic. Operates with 1 AA battery, without battery. MOQ: 50 pcs. 150x220 mm
Printing: FP (FC, 150x220 mm)

With your own digitally printed design!



new

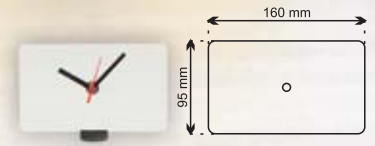

BeTime A AP718052

Custom made, HDF wood table clock with custom graphic and plastic stand. Operates with 1 AA battery, without battery. MOQ: 50 pcs. 160x95 mm
Printing: FP (FC, 160x95 mm)

AP806802

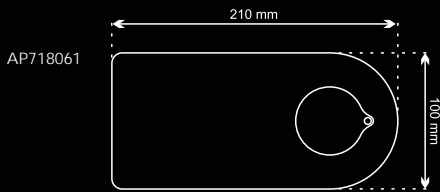
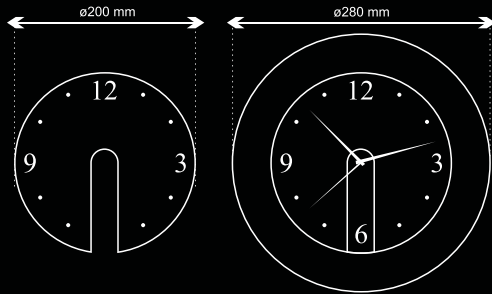

new



Cabine AP718061

Custom made, HDF wood doorhanger and keyring set, with custom graphic on one side. MOQ: 50 sets. 100x210x3 mm
Printing: FP (FC, 100x210 mm)



BE CREATIVE



Brattain AP806802

Plastic, round wall clock with two changeable clock faces (white and black). Operates with 1 AA battery, without battery. Custom made digital printed clock face can be produced on request. ø280 mm
Printing: S1 (2C, 50x20 mm), DG2 (FC, ø200 mm)



new



Brew AP718062

Custom made, HDF wood coaster with custom graphic on one side. MOQ: 100 pcs. 95x95 mm
Printing: FP (FC, 95x95 mm)

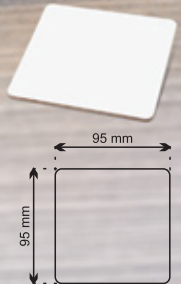



new

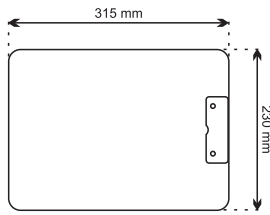

Woopy AP718056

Custom made, A4 sized HDF wood clip board with custom graphic on front side. MOQ: 50 pcs. 230x315 mm
Printing: FP (FC, 230x315 mm)

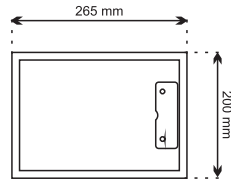

Clipsy A5 AP718041

Custom made, A5 sized clip board with custom graphics on both sides. MOQ: 50 pcs. 160x225 mm
Printing: FP (FC, 160x225 mm)

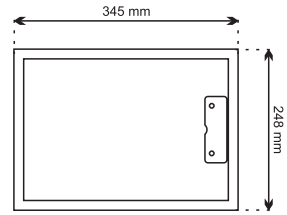

Clipsy A4 AP718040

Custom made, A4 sized clip board with custom graphics on both sides. MOQ: 50 pcs. 220x315 mm
Printing: FP (FC, 220x315 mm)

BE CREATIVE



Cooler A4 AP718032

Custom made, A4 sized binder folder with custom graphics on the cover. MOQ 50 pcs.
245×320×35 mm
Printing: FP (FC, 530×320 mm)



Cooler A5 AP718033

Custom made, A5 sized binder folder with custom graphics on the cover. MOQ 50 pcs.
185×235×35 mm
Printing: FP (FC, 407×235 mm)

*With your own
digitally printed
design!*

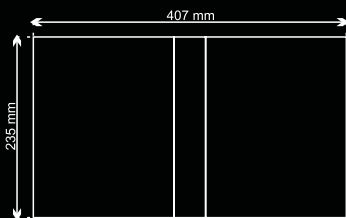

AP718033

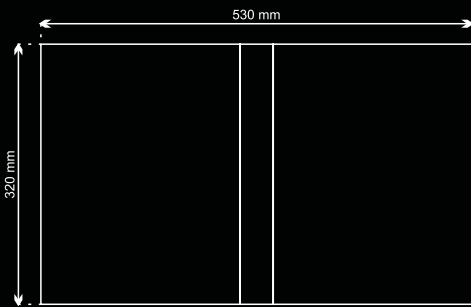

AP718032

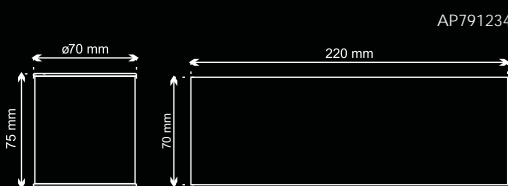

AP791234



-05
-06
-01

Rublo AP791234

Can shaped, metal coin bank.
ø70×75 mm
Printing: P1 (2C, 30×40 mm), VS (FC, 70×220 mm)

Customise them with digitally printed paper insert!

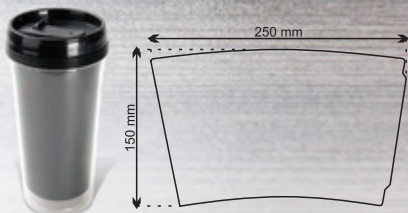

Poster AP811103

Double wall, plastic thermo mug with drinking lid. Custom graphic can be placed between the 2 walls of the mug. Delivered in white paper box. 450 ml. ø85×170 mm
Printing: DG2 (FC, 250×150 mm)

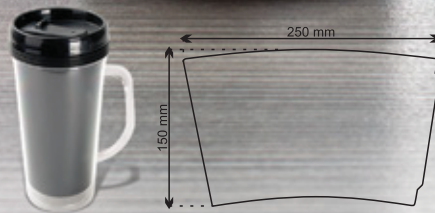

Grabster AP807931

Double wall, plastic thermo mug with handle and drinking lid. Custom graphic can be placed between the 2 walls of the mug. Delivered in white paper box. 450 ml. ø85×170 mm
Printing: DG2 (FC, 250×150 mm)

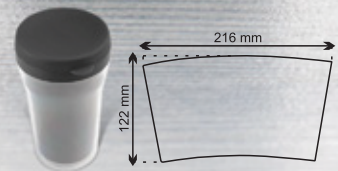

Doppler AP807930

Plastic, double wall thermo mug with lid. Custom graphic can be placed between the 2 walls of the mug. Delivered in white paper box. 250 ml. ø70×130 mm
Printing: DG2 (FC, 216×122 mm)

Produced in custom shapes!

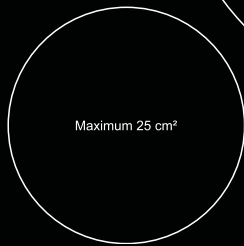
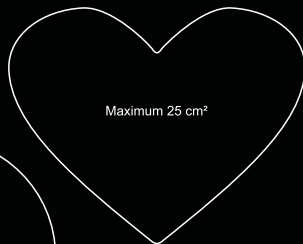
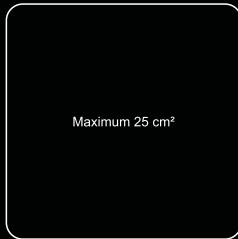

BE CREATIVE

EpoFridgy AP718004E

Custom made epoxy coated fridge magnet with unique shape and digital printing.
MOQ: 100 pcs.
Max 25 cm²
Printing: FP (FC, Max 25 cm²)



Fridgy AP718004

Custom made fridge magnet with unique shape and digital printing. MOQ: 100 pcs.
Max 25 cm²
Printing: FP (FC, Max 25 cm²)



1. Pick your colour!

-01 -02 -05 -06 -07 -10



2. Choose your shape!



new
colours &
shapes

Digibreeze AP718029

Custom made fan with plastic handle and laminated paper. Digital printed with your graphic on both sides. MOQ: 100 pcs.
170x235 mm
Printing: FP (FC, 172x143 mm)

3. Design it!





Block AP757004-10

Square shaped, PU leather keyring with metal ring. With epoxy domed metal part in the middle. Price includes epoxy dome printing. MOQ: 100 pcs. 40x57 mm
Printing: FP (FC, 28x28 mm)

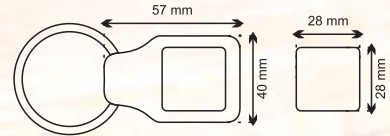

Customise them with epoxy doming!

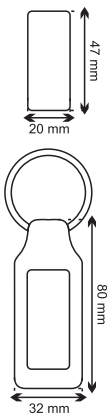

Ticket AP757002-10

Rectangular shaped, PU leather keyring with metal ring. With epoxy domed metal part in the middle. Price includes epoxy dome printing. MOQ: 100 pcs. 32x80 mm
Printing: FP (FC, 20x47 mm)

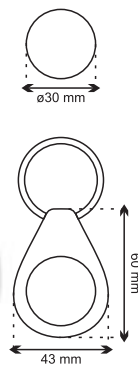

Clap AP757003-10

Round shaped, PU leather keyring with metal ring. With epoxy domed metal part in the middle. Price includes epoxy dome printing. MOQ: 100 pcs. 43x60 mm
Printing: FP (FC, ø30 mm)



new

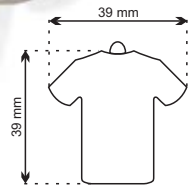

Eleven AP810725

T-shirt shaped metal keyring with epoxy dome. Price includes epoxy dome printing. MOQ: 100 pcs. 41x42x2 mm
Printing: FP (FC, 39x39 mm)

BE CREATIVE

new



Dupoxy AP809517

Round shaped metal keyring for epoxy dome printing on both sides. Price includes the epoxy dome printing. MOQ: 100 pcs. 40x95 mm
Printing: FP (FC, 2 x ø38 mm)



Keeper AP810729

T-shirt shaped keyring with epoxy dome. Price includes epoxy dome printing. MOQ: 100 pcs. 43x30 mm
Printing: FP (FC, 43x30 mm)

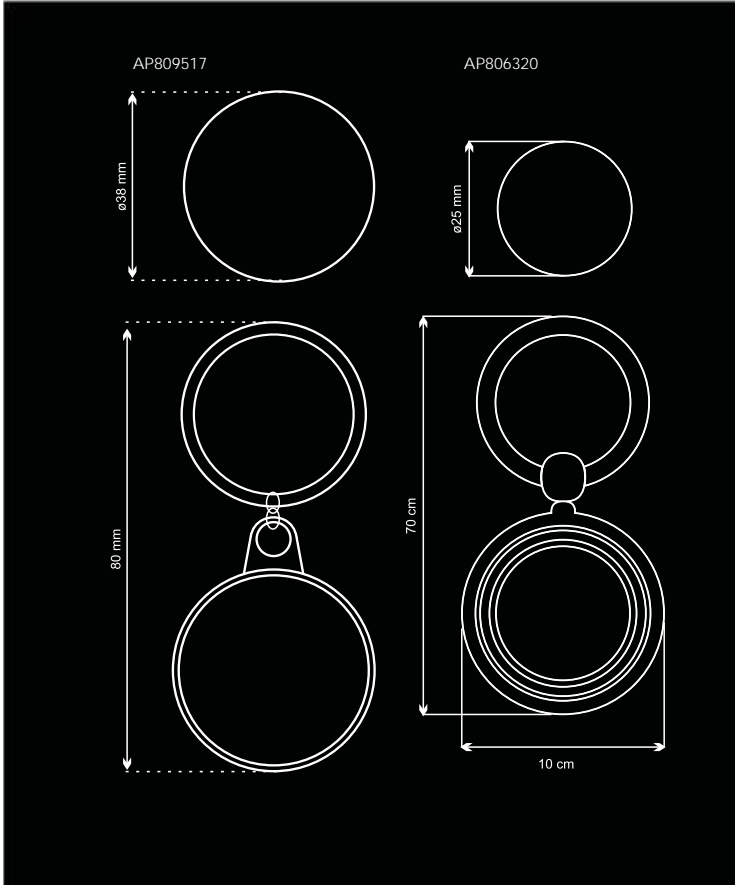
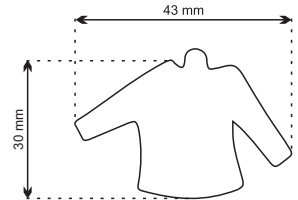

Carousel AP806320

Keyring with turnable inner area, in black gift box. 35x95 mm
Printing: P2 (2C, ø25 mm), DO2 (FC, ø25 mm)





EpoRing AP809326

Keyring made of custom shaped epoxy domes. With metal chain. Price includes epoxy dome printing. MOQ: 100 pcs. Printing: FP (FC, Max 25 cm²)

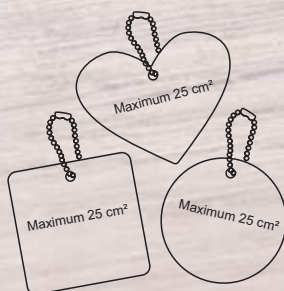

new

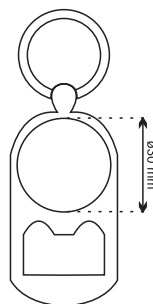

Bubbles AP810724

Metal bottle opener with keyring and epoxy dome. In black gift box. Price includes epoxy dome printing. MOQ: 100 pcs. 35x65x3 mm. Printing: FP (FC, ø30 mm)



new



Breck AP810730

Square shaped metal keyring with epoxy dome. Price includes epoxy dome printing. MOQ: 100 pcs. 30x33 mm. Printing: FP (FC, 30x30 mm)

*Customise them
with epoxy doming!*

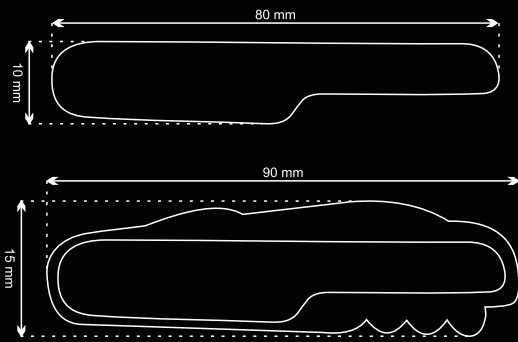

AP807208



Match AP807208

Stainless steel pocket knife with 5 functions and flat surface. Price does not include epoxy dome printing.
90×15×7 mm
Printing: DO2 (FC, 80×10 mm)



BE CREATIVE

Coder AP809370

Plastic ballpoint pen with coloured upper part and square shaped clip. With blue refill. Ideal for printing QR Code.
ø10×145 mm
Printing: P1 (2C, 50×7 mm), DO1 (FC, 18×18 mm), UV (FC, 18×18 mm)

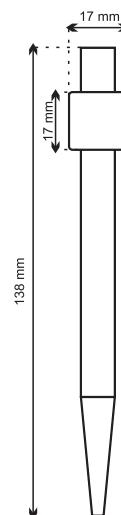
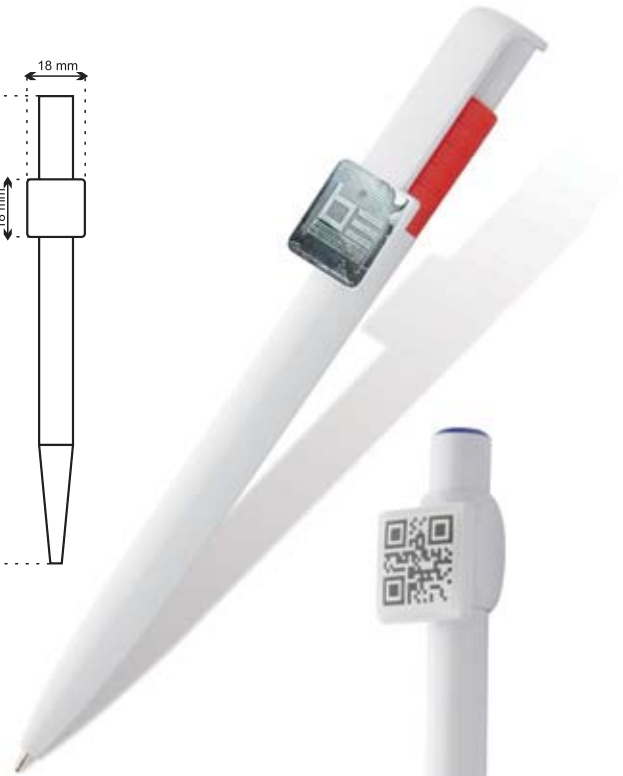
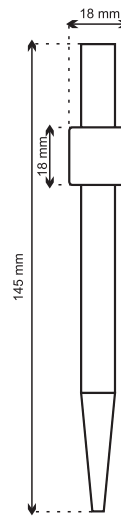

Neix AP741128

Plastic ballpoint with coloured tip and square shaped clip. With blue refill. Ideal for printing QR Code.
ø10×138 mm
Printing: P1 (2C, 50×7 mm), DO1 (FC, 17×17 mm)

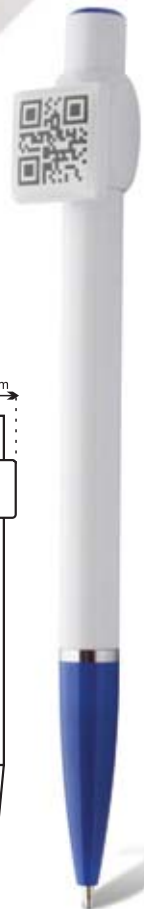

EpoBadge Midi AP718030

Custom made epoxy domed badge with metal pin. With custom graphics and shape. Maximum size: 9 cm². MOQ: 100 pcs. Printing: FP (FC, Max 9 cm²)

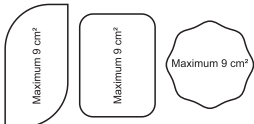

EpoBadge Maxi AP718031

Custom made epoxy domed badge with metal pin. With custom graphics and shape. Maximum size: 15 cm². MOQ: 100 pcs. Printing: FP (FC, Max 15 cm²)

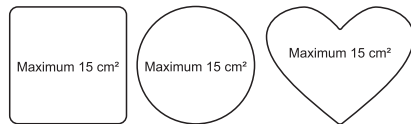

Trick AP810728

T-shirt shaped metal badge with epoxy dome. Price includes epoxy dome printing. MOQ: 100 pcs. 30x25 mm. Printing: FP (FC, 30x25 mm)

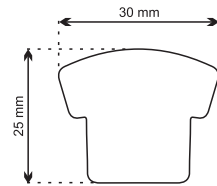

new



Chorum AP809515

Metal business card holder with shiny surface. Price includes epoxy dome printing. MOQ: 100 pcs. 90x55mm. Printing: FP (FC, 92x55 mm)



Chrome AP810356

Stainless steel business card holder and keyring in black gift box. 93x160x12 mm. Printing: DO3 (FC, 92x55 mm)



Customise them with epoxy doming!

AP809515; AP810356

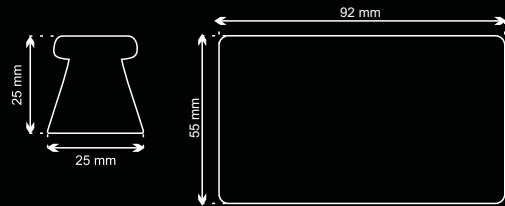

BE CREATIVE

EpoPlug AP718068

Custom made epoxy dome mobile phone charm with 3.5 mm Jack plug holder. With custom graphics and shape. Maximum size: 15 cm².
MOQ: 100 pcs.
Max. 15 cm²
Printing: FP (FC, Max 15 cm²)

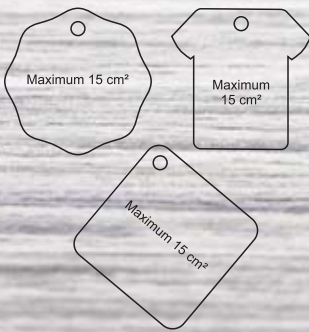

new



new



new



EpoClean AP718066

Custom made, round shape epoxy domed screen cleaner with metal chain. MOQ: 100 pcs.
ø30 mm
Printing: FP (FC, ø30 mm)

EpoPhone AP718067

Custom made, round shape epoxy domed screen cleaner with 3.5 mm Jack plug holder. MOQ: 100 pcs.
ø30 mm
Printing: FP (FC, ø30 mm)



new

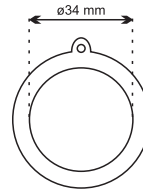

Foldy AP809371

Plastic bag hanger with metal keyring and epoxy dome. Price includes epoxy dome printing. MOQ: 100 pcs. ø45x8 mm
Printing: FP (FC, ø34 mm)



-01 -02 -05 -06 -07 -10

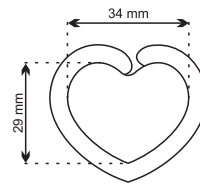

Amor AP810727-05

Heart shaped, metal bag hanger with magnetic closure. In black gift box. 35x30x5 mm
Printing: DO2 (FC, 34x29 mm)



new



-01 -01 -01

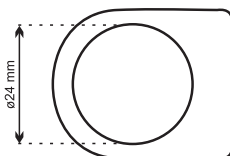

MagNote AP809540

Metal note clip with magnet on the back side. Ideal for epoxy dome printing. 30x35x23 mm
Printing: DO1 (FC, ø24 mm)



-01 -03 -05 -06 -07 -10 -21

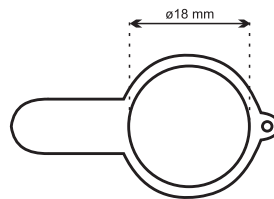

Mavericks AP809367

Plastic touch screen pen with 3.5 mm Jack plug holder. Price includes epoxy dome printing. MOQ: 100 pcs. 35x20 mm
Printing: FP (FC, ø18 mm)

*Customise them
with epoxy doming!*

AP878003

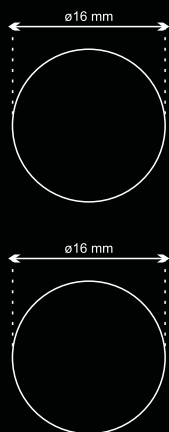

AP810723

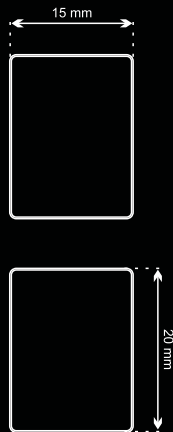

BE CREATIVE



Rylan AP878003

Epoxy domed, nickel plated brass cufflinks. In plastic gift box (77x39x26mm). Price includes epoxy dome printing. MOQ: 100 pcs. ø16,2 mm
Printing: FP (FC, ø16 mm)

Master AP810723

Shiny metal cufflink set in black gift box. Price includes epoxy dome printing (20x15 mm logos). MOQ: 100 pcs. 80x35x75 mm
Printing: FP (FC, 2 x 20x15 mm)



Maestro AP810722

Shiny metal cufflink and tie clip set in black gift box. Price includes epoxy dome printing (15x10 mm logo on tie clip and 20x15 mm logos on cufflinks). MOQ: 100 pcs. 80x35x75 mm
Printing: FP (FC, 15x10 mm, 2 x 20x15 mm)

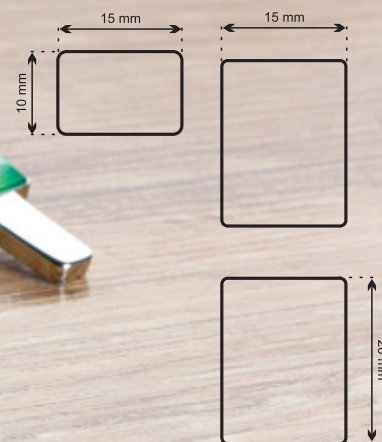

ReXmark AP809408

Plastic bookmark with 8 cm ruler.
127×30×5 mm
Printing: P1 (4C, 20×20 mm),
UV (FC, 30×33 mm)

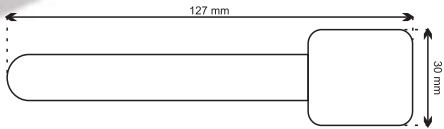

Medication AP809334-01

Foldable, plastic travel cup with pill holder.
ø70×25 mm
Printing: P1 (2C, ø50 mm), UV (FC, ø65 mm)

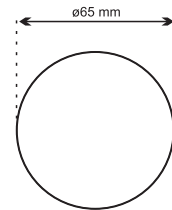
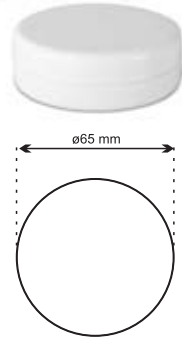

-01 -03 -05 -06 -07

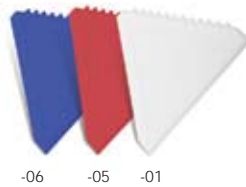

-06 -05 -01

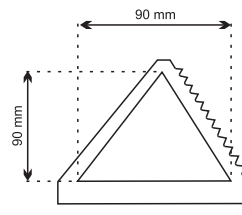
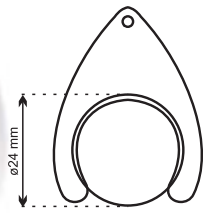

Nelly AP800375

Plastic shopping cart coin with metal keyring.
Coin size: ø24×2 mm.
44×33×5 mm
Printing: P1 (2C, 12×10 mm), UV (FC, ø24 mm)

Tri Scrap AP800342

Triangle shaped plastic ice scraper.
115×115×109 mm
Printing: P1 (2C, 30×30 mm), UV (FC, 90×90mm)



Customise them
with UV LED
printing!

AP741187

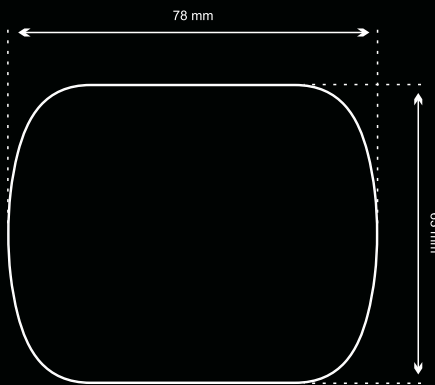

BE CREATIVE



Elyan AP741187

Plastic pill box with 4 compartments.
78×16×63 mm
Printing: P1 (4C, 50×40 mm), UV (FC, 78×63 mm)



Click AP896001

Round, metal mint box with 12 gramm
menthol candies. Can be opened by
pressing the cap.
ø45×15 mm
Printing: UV (FC, ø45 mm)

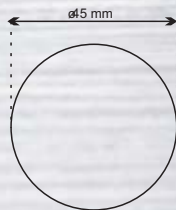

Card AP896000

Card shaped, transparent plastic mintbox with cca.
50 menthol candies.
75×45×5 mm
Printing: P1 (2C, 50×30mm), UV (FC, 75×45 mm)

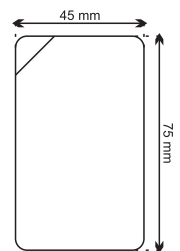



-01 -03 -05 -06

Gill AP809318

Aluminium pocket mirror with normal and magnifying sides.
 ø60×6 mm
 Printing: P2 (2C, ø40 mm), UV (FC, ø60 mm)

Thinly AP731471

Round, transparent plastic pocket mirror.
 ø62 mm
 Printing: P1 (2C, ø58 mm), UV (FC, ø60 mm)

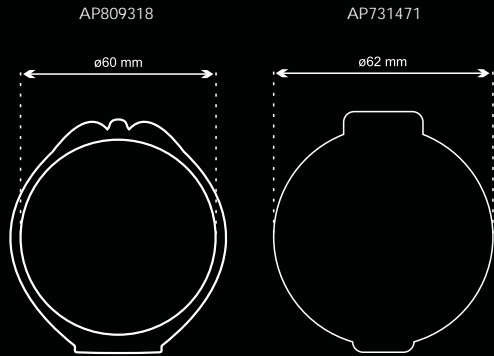

*Customise them
 with UV LED
 printing!*

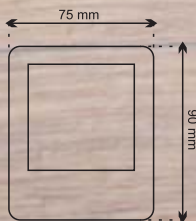

Melanie AP761886

Plastic mini puzzle with printable surface.
 75×90 mm
 Printing: P1 (2C, 50×50 mm), UV (FC, 55×55 mm)

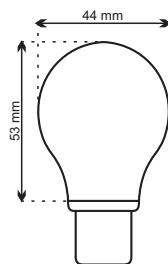

Nadol AP741152-01

Light bulb shaped plastic highlighter.
 44×75×16 mm
 Printing: P1 (4C, 30×30 mm), UV (FC, 44×53 mm)

Soccer AP810357-01

Sport dress shaped plastic bottle opener with keyring. Material: ABS. 80x66x4.5 mm. Printing: P1 (4C, 25x25 mm), UV (FC, 80x66 mm)

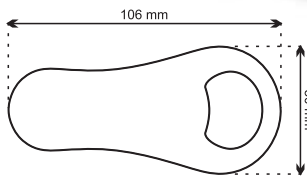
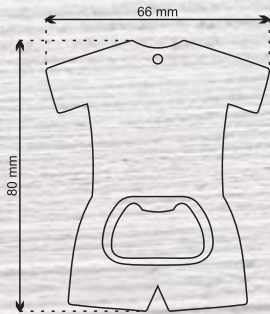

Tronic AP731974

Plastic bottle opener with fridge magnet. 55x106x5 mm. Printing: P0 (2C, 50x15 mm), UV (FC, 55x106 mm)

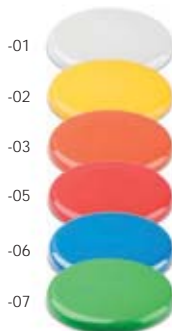

Smooth Fly AP809473

Plastic frisbee with flat surface. Ideal for printing. ø230x20 mm. Printing: S0 (2C, ø175 mm), UV (FC, ø200 mm)

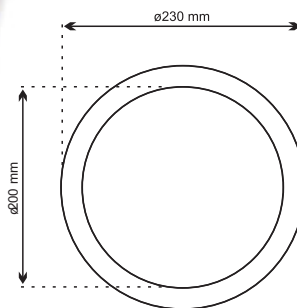

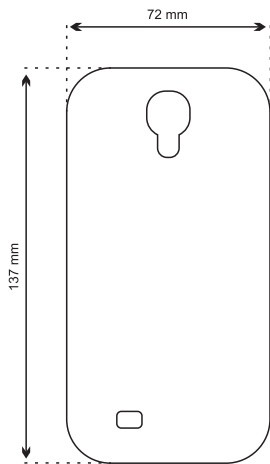

Andromeda AP809469

Plastic Samsung Galaxy S4® case. The back of the item can be customised with UV LED printing.
72×137mm
Printing: P2 (4C, 60×40 mm), UV (FC, 72×137 mm)



Puzzle AP800354-01

Acrylic and ABS dual-power calculator with 8-digit display and puzzle-game at back. With button cell battery.
124×61×13 mm
Printing: P2 (2C, 40×60 mm), UV (FC, 40×60 mm)

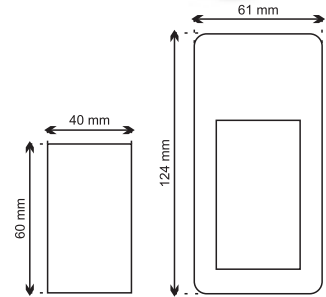

High Five AP809463

Plastic iPhone® case. The back of the item can be customised with UV LED printing. Compatible with iPhone 5.
60×125×8 mm
Printing: P2 (2C, 25×10 mm), UV (FC, 60×125 mm)

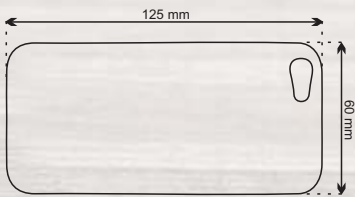

Customise them with UV LED printing!

BE CREATIVE



AP800373-01



Washington AP800373-01

Plastic luggage tag with paper insert.
110×60×3 mm
Printing: P1 (2C, 70×40 mm), UV (FC, 110×60 mm)

Redax AP833011

Credit card shaped, plastic USB flash drive.
Capacity: 2/4 GB.
85×54×2,7 mm
Printing: P1 (2C, 85×50 mm), UV (FC, 85×54 mm)

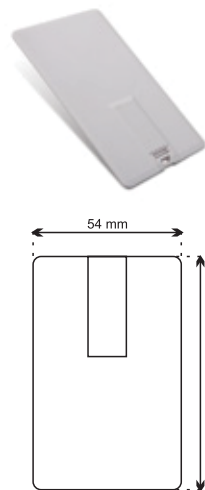

Cort AP791192

In-ear earphones with 3.5 mm audio Jack and 3 pairs of earbuds, in plastic case.
70×20×70 mm
Printing: P2 (4C, 25×25 mm), UV (FC, 68×68 mm)

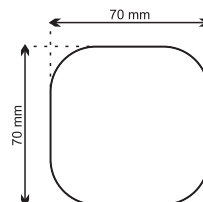

Marathon AP811106

Aluminium sport bottle with plastic drinking lid, 500 ml.
 ø65×210 mm
 Printing: P2 (2C, 30×30 mm), C3 (8C, 206×143 mm)



**new
colour**

Mento AP731964

Aluminium sport bottle with carabiner, 400 ml.
 ø66×175 mm
 Printing: C3 (8C, 209×110 mm), E1 (20×80 mm)



Arabica AP848000

Coloured stainless steel vacuum flask, 500 ml.
 ø70×245 mm
 Printing: P2 (1C, 30×30 mm), C3 (8C, 205×170 mm)



*Customise them
with XP printing!*

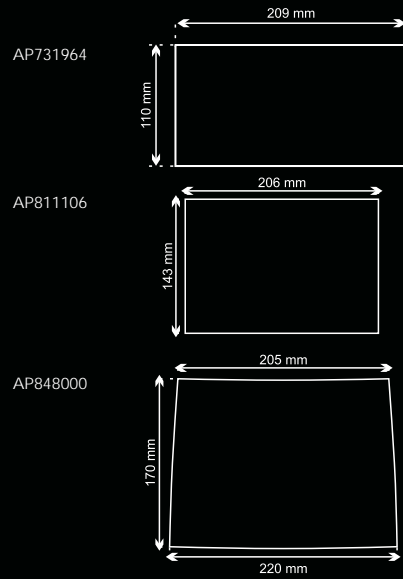

PRINTING TECHNOLOGIES



PAD PRINTING

Pad printing is used for labelling plastic, metal, wood and paper products. Small sized, high accuracy and high resolution prints can be made. The special advantage of tampon printing is the possibility of printing on curved surfaces. Tampon printing is the most popular printing method.



SCREEN

Screen printing is the method for labelling textiles, plastic and paper products with flat or flattenable surface. The ink is directly pressed on the product's surface through a gauze and fixed with 170°C heat treatment. This technology provides high colour accuracy.



TRANSFER

Transfer printing is ideal for items which cannot be screen printed due to their size or shape. The logos are printed on a transfer paper, then transferred to the item by high-temperature heat transfer press. Transfer imprints have good washing resistance and high colour accuracy.



CERAMIC & XP TECHNOLOGY

Ceramic printing is used to label mugs and glasses using special ceramic and glass points fired on high temperature. The label is applied to the product similarly to transfer printing, then fired in a furnace. The XP technology can be applied to metal and wooden items, it works the same way as ceramic printing.



UV LED TECHNOLOGY

UV LED technology is digital printing directly on the product's surface. Due to the special technology the imprints are fixed without any heat treatment, which provides instant, photo quality result. This technology can be used on metal, wooden, plastic and glass items.



EPOXY DOMING

Logos made with epoxy doming are printed on a sticker and coated with a 2 component resin. As a result, the treated surface will be very flexible and have a 3-dimensional look. Epoxy domed logos can be produced in custom shapes and are resistant to UV rays.



SUBLIMATION

This printing method can be applied to special sublimation mugs, cleaning clothes, T-shirts and beach slippers. Sublimation printing tears down virtually every wall in the path of photo quality. Logos printed with sublimation are high-resolution, detailed, bright and vivid coloured pictures.



DIGITAL

With large-format digital printing you have the possibility to label special stickers, posters, banners, or create custom shaped paper inlets for various items in photo quality. Digital prints are UV-resistant and waterproof by using corresponding raw materials.



3D ENGRAVING

3D engraving is the latest printing technology. It generates a laser focal point inside a glass item, creating bubbles caused by micro-explosions. 3D engraved graphics are ranging from one-two thousand to hundreds of thousands bubbles, depending on the detail of the logo.



ENGRAVING

This technology utilises lasers to engrave an object. The imprint's depth can be measured in a hundredth of a millimetre compared to the previous mechanical procedures. The surface of the product practically burns in the process to develop the logo. Even small logos can be printed very accurately.



EMBOSSING

Embossing uses a specially-made die under high pressure to form a raised 3D impression that allows you to literally feel the logo. Embossing can be with hot foil stamping to add texture or metallic colour to the embossed logo. Embossing can be used on leather, paper and certain wooden items.



EMBROIDERY

This procedure is for labelling textile products. Firstly, each logo must be programmed by embroidery software for the machine. Following, the logos are embroidered by the automated machines. Exact pantone colours are not achievable, due to limited thread colours.



Logos on the products of this catalogue are only exhibited for the purpose of displaying printing possibilities and are not reference for sale. Accordingly, products are merchandised without the displayed logos.

The right is reserved to deliver products that differ, in execution and in colours, from items illustrated in this catalogue. The displayed product printing parameters may differ from actual possibilities.

Products are delivered without decoration and battery, unless otherwise indicated.

Yardim^{AP791454}

37 pcs first aid kit in transparent, plastic case.
95x13x30 mm

Printing: P2 (2C, 50x20 mm)

- Max print size.
- Max print colours. (FC=full colour)
- Printing price category.
- Printing technology.

CODE	PRINTING TECHNOLOGIES
P	Pad printing
T	Transfer printing
S	Screen printing
RS	Cylindrical screen printing
C	Ceramic and XP printing
E	Engraving
3D	3D engraving
O	Embossing
BR	Embroidery
WP	Transfer printing on white base
WPC	Transfer printing on white ceramics
VS	Vinyl sticker
DO	Epoxy doming
SU	Sublimation
UV	UV Led printing
DG	Digital paper insert
VF	Vision Film printing
FP	Price includes printing with indicated technology. Excluding setup charge.

 **andré philippe**

ASPEN®

■ ■ ANTONIO MIRO ■ ■

Alexluca
Italy

pierre cardin

Guriatti

